

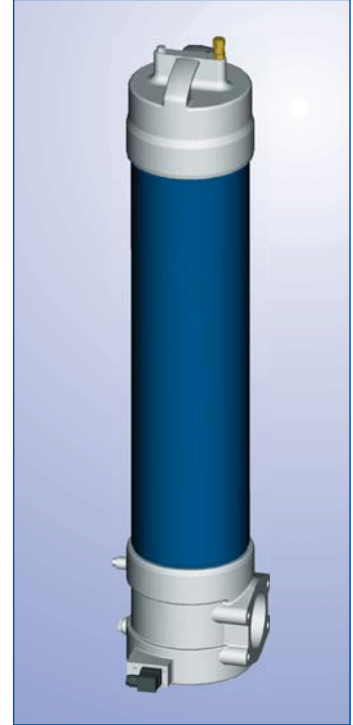

Filters . Accumulators

Complete Range

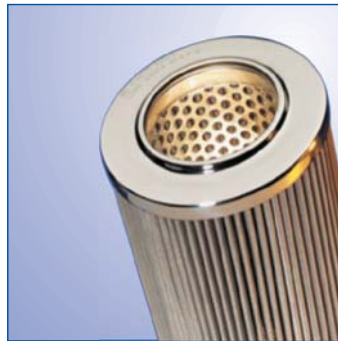

Industrial Filters and Hydropneumatic Accumulators





EPE

Particle counters

Type	Pressure	Flow rate
Contamination monitor according to ISO4406:1999 or SAE AS4059.	upto 420 bar	50... 400 ml/min



EPE

Breather filters

Type	Pressure	Connection
TLF-I, TLF-II, TLF-III	–	G 1 . . . G 3



EPE

Suction filters

Type	Pressure	Connection
S, SE	–	G 3/8 . . . SAE 4"



EPE

Spin on filters

Type	Pressure	Connection
SL, SLS, SLD	7, 25, 50 bar	G 3/4 . . . SAE 1-1/2"

Return line filters

Type	Pressure	Connection
10/16 FRE 10/16 FREN..... DIN 24550	10/16 bar	G 1/2 . . . DN 300



EPE

Duplex return line filters

Type	Pressure	Connection
10/16 FRD 10/16 FRDN..... DIN 24550	10/16 bar	G 1/2 . . . DN 300



EPE

In-line filters

Type	Pressure	Connection
40/160 LE 40/160 LEN..... DIN 24550	40/160 bar	G 1 . . . G 1 1/2
40/100 FLE 40/100 FLEN..... DIN 24550	40/100 bar	DN 50 . . . DN 100
40 FLE 40 FLEN..... DIN 24550	40 bar	SAE 4"
16 FLE 16 FLEN..... DIN 24550	16 bar	DN 125 . . . DN 300



EPE

High pressure filters

Type	Pressure	Connection
250/450 LE 250/450 LEN..... DIN 24550	250/450 bar	G 3/4 . . . SAE 2 1/2"
250/450 FE 250/450 FEN..... DIN 24550		DN 14 . . . DN 50



EPE

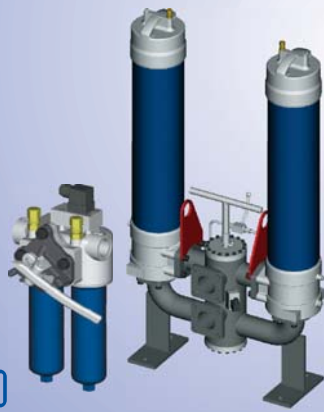

EPE

Duplex filters

Type	Pressure	Connection
40/160 LD 40/160 LDN..... DIN 24550	40/160 bar	G 1... SAE 1 1/2"
40/160 FLD 40/160 FLDN..... DIN 24550	40/160 bar	DN 50... DN 100
40 FLD 40 FLDN..... DIN 24550	40 bar	DN 100
16 FLD 16 FLDN..... DIN 24550	16 bar	DN 125... DN 300



EPE

High pressure duplex filters

Type	Pressure	Connection
250/450 LD 250/450 LDN..... DIN 24550	250/450 bar	G 1/2... SAE 2"



EPE

Duplex filters with ball valve

Type	Pressure	Connection
FLDK	10/16/40 bar	DN 25... DN 100...



EPE

Duplex filters with electric changeover

Type	Pressure	Connection
DE	10 bar	DN 50... DN 100

Automatic Back wash filters

Description

Designed for continuous operation for various low-viscosity fluids like water, fuel, coolants etc.

Compact design with low maintenance cost.



EPE

Special design

Description

Custom-built filtration solutions



EPE

Offline filter systems

Type	Nominal flow rate	Pressure
NFF	10 - 170 l/min.	2 - 8 bar



EPE

Filter elements

Type	Pressure	Filter grade
1., 2., 3., 4., 7.	ΔP 15... 330 bar	1... 2000 μm

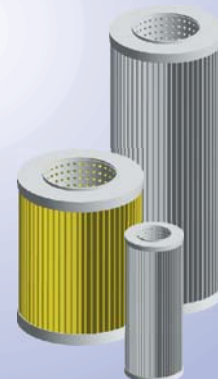

EPE

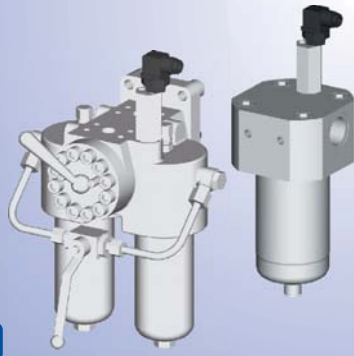

EPE

Process and Industrial filters

Type	Pressure	Connection
EL, ED, G, DG, LW, DLW, DFLW, SFE, BFE	1 . . . 3000 bar	G 1/2 . . . DN 500



EPE

Maintenance indicators

Type	Pressure	Indicator options
Static pressure - differential pressure indicator	1 - 450 bar	Optical, Optical-Electrical, Electronic



EPE

Skids / Packaged systems

Description

Designed according to customer's specifications relating to varied applications like lubrication, flushing, forwarding, metering etc..



EPE

Accumulator stations

Description

Accumulator systems & stations with single/multiple Accumulators (bladder/piston type), Nitrogen back-up bottles, individual safety blocks, charging blocks, safety relief valves, necessary piping (gas & liquid side)... Duly mounted on common stand.

Application : Energy storage.

Bladder Accumulators

Type	Pressure	Nominal capacity
Bladder accumulators AS, ASHF, ASWD, ASWD	10 - 550 bar	0.2 - 55 Ltrs



EPE

Diaphragm Accumulators - welded

Type	Pressure	Nominal capacity
Diaphragm accumulators AMW	40 - 350 bar	0.075 - 5 Ltrs



EPE

Diaphragm Accumulators - screwed

Type	Pressure	Nominal capacity
Diaphragm accumulators AM	10 - 210 bar	0.1 - 5 Ltrs

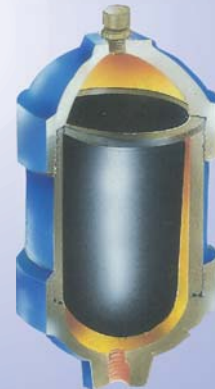

EPE

Piston Accumulators

Type	Pressure	Nominal capacity
Piston accumulators AP	220 - 800 bar	0.75 - 1500 Ltrs



EPE



Filters . Accumulators

Other Products of Interest

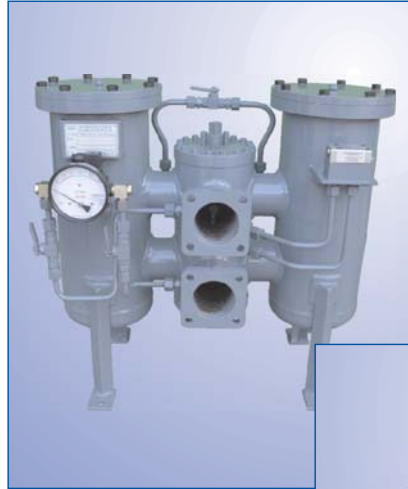

EPE PROCESS FILTERS & ACCUMULATORS PVT LTD

Techni Towers
C-54/A, A.P.I.E., Balanagar
Hyderabad -500 037, A.P., India.
Tel. Nos. : 23778803/23778804/23871445
Fax Nos. : 040-23871447.
Internet : www.epe-india.com
E-mail : business@epe-india.com