



Filters . Accumulators
an ISO 9001 Company

General

The Safety Block contains in one compact unit all the components required for easily connecting the accumulator to the hydraulic circuit and its protection from overpressure. It also allows for quick dismounting of the accumulator or checking the precharge pressure during the system operating.

Construction

Standard version includes

- Body in Phosphated steel.
- 3-Way ball valve in chrome-plated steel connecting accumulator (A) to inlet (P) or discharge (T).
- Seat for assembling of relief valve.
- Installation side connection - BSP(F) parallel threaded.
- Accumulator side connection - BSP(M) / Metric (Male) suitable for the Accumulator.
- Flow Control Valve for adjusting the flow rate during the Accumulator discharge (only on B20).
- Connections for accumulator discharge (T) and pressure gauge (M)
- Gaskets for mineral oil (Nitrile)

- On request** it is supplied with
- Body in Nickle Coated Carbon Steel or SS
 - Nipple for connection to Accumulator Relief Valve.
 - Two-Way Solenoid Valve for electrical discharge, normally open.
 - Gaskets in Viton

Accumulator Safety Block, Type-B10-20



Technical Features

- Diameter of inlet port : 10 and 20 mm
- Nominal flow rates at ~6m/s: B10 = 30 lpm; B20 = 115 lpm.
- Max. Working pressure : 330 Bar.
- Temperature range : -15 to +80 C (60 C with solenoid valve).
- Relief valve : Port Dia = 10mm
Set at specified pressure 5 to 330 bar.
- Solenoid valve : Power voltage = DC 24V / AC 110/220V
Power consumption = 20W - 67Va
Protection = IP54

Identification Code

B20	M	B	210	G	R	P	-
Type and Inlet Port	Discharge	Safety Valve	Relief Valve Setting (bar)	Accumulator Side Connection	Installation Side Connection	Gasket Material	Block Material
B 10 B 20	M = Manual E = Electric	A = Without Valve B = Calibrable Valve without testing P = Valve (CE certified)	210 330 Other Settings on request	N = Without Nipple B10 G = Nipple 2" BSP G1 = Nipple 1-1/4" BSP G3 = Nipple 3/4" BSP M1 = Nipple M40x1.5 M2 = Nipple M50x1.5 S = Special ⁽¹⁾ R20 G = Nipple 2" BSP G1 = Nipple 1-1/4" BSP M = Nipple M50x1.5 S = Special ⁽¹⁾	R = B10 R = 1/2" BSP(F) R = B20 R = 3/4" BSP(F)	P = Nitrile V = Viton	- = Phosphated Steel N = Nickle Coated Carbon Steel X = Stainless Steel

⁽¹⁾ Specify details in full

EPE EPE PROCESS FILTERS & ACCUMULATORS PVT LTD
An ISO 9001 Company

Techni Towers
C-54/A, A.P.I.E., Balanagar
Hyderabad -500 037. A.P., India.
Tel. Nos. : 23778803/23778804/23871445
Fax Nos. : 040-23871447.
Internet : www.epe-india.com
E-mail : business@epe-india.com.



Note : Technical specifications are subject to change.

Catalogue Ref. : EPE/NP/001

Accumulator Safety Block, Type-B10-20

Dimensions

- BLOCK TYPE B10
- MANUAL DISCHARGE

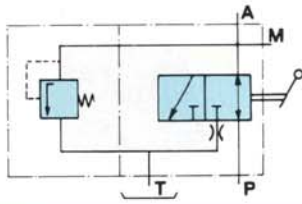

Without relief valve

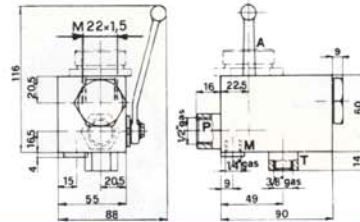

With relief valve calibrable

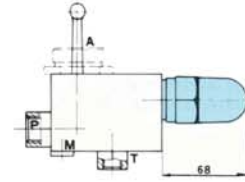

Weight: 3 kg

- BLOCK TYPE B10
- WITH RELIEF VALVE
- WITH ELECTR. & MANUAL DISCHARGE

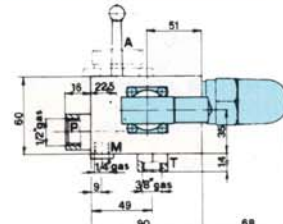
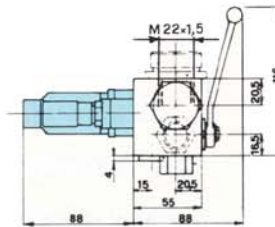
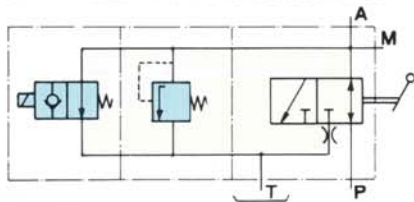

Weight: 3,5 kg

- BLOCK TYPE B20
- MANUAL DISCHARGE

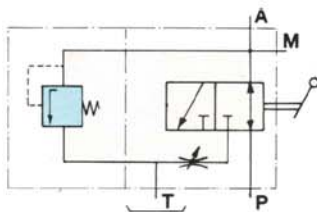

Without relief valve

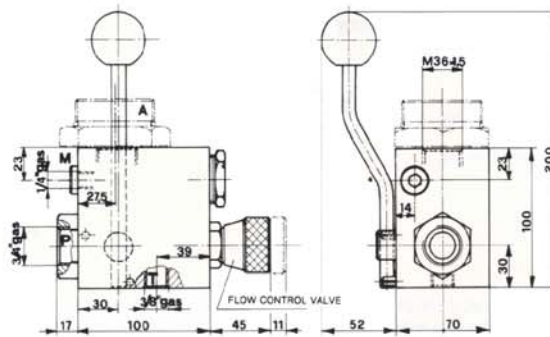

With relief valve calibrable

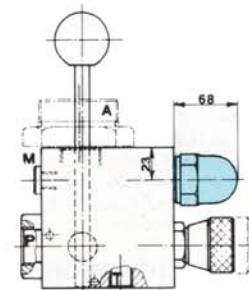

Weight: 6,4 kg

- BLOCK TYPE B20
- WITH RELIEF VALVE
- WITH ELECTR. & MANUAL DISCHARGE

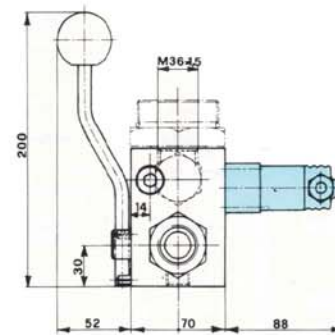
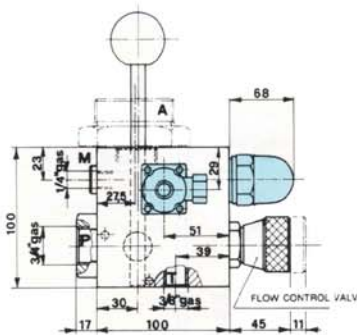
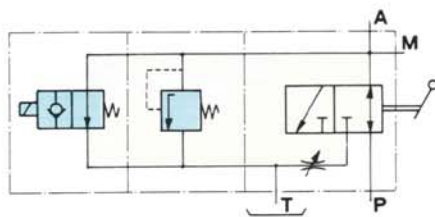

Weight: 6,9 kg

DBDS RELIEF VALVE

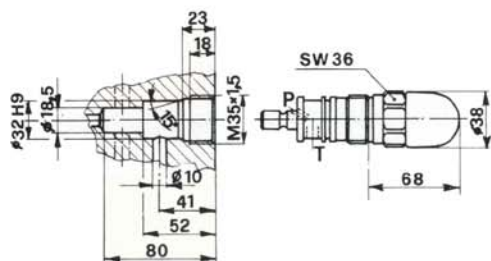

NIPPLE (with O-ring) to connect block-accumulator

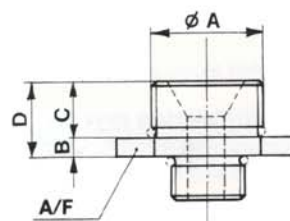

Part No.	Type	Ø A	B	C	D	A/F
10450	B10	3/4" BSP	6	14	20	36
10451		1" 1/4 BSP	6	14	20	50
10452		2" BSP	8	16	24	70
10453		M40x1,5	6	14	20	50
10454		M50x1,5	8	16	24	70
10470	B20	1" 1/4 BSP	10	16	26	50
10471		2" BSP	10	20	30	70
10472		M 50x1,5	10	20	30	70

All dimensions in mm

Subject to change